

DYMO®

RHINO™ 6000+

User Guide

newell
BRANDS

Copyright

© 2021 Newell Office Brands All rights reserved. Rev: 11/22

No part of this document or the software may be reproduced or transmitted in any form or by any means or translated into another language without the prior written consent of Newell Office Brands.

Trademarks

DYMO, DYMO ID, and RHINO are registered marks in the US and other countries. All other trademarks are the property of their respective holders.

FCC Statement

Caution: The user is cautioned that changes or modifications not expressly approved by the party responsible for compliance could void the user's authority to operate the equipment.

Note: This equipment has been tested and found to comply with the limits for a Class B digital device, pursuant to part 15 of the FCC Rules. These limits are designed to provide reasonable protection against harmful interference in a residential installation. This equipment generates, uses and can radiate radio frequency energy and, if not installed and used in accordance with the instructions, may cause harmful interference to radio communications. However, there is no guarantee that interference will not occur in a particular installation. If this equipment does cause harmful interference to radio or television reception, which can be determined by turning the equipment off and on, the user is encouraged to try to correct the interference by one or more of the following measures:

- Reorient or relocate the receiving antenna.
- Increase the separation between the equipment and receiver.
- Connect the equipment into an outlet on a circuit different from that to which the receiver is connected.
- Consult the dealer or an experienced radio/TV technician for help.

IC Statement

This device contains license-exempt transmitter(s)/receiver(s) that comply with Innovation, Science and Economic Development Canada's licence-exempt RSS(s). Operation is subject to the following two conditions:

(1) This device may not cause interference.

(2) This device must accept any interference, including interference that may cause undesired operation of the device.

This equipment complies with Industry Canada radiation exposure limits set forth for an uncontrolled environment.

Le présent appareil est conforme aux CNR d'Industrie Canada applicables aux appareils radio exempts de licence. L'exploitation est autorisée aux deux conditions suivantes : (1) l'appareil ne doit pas produire de brouillage, et (2) l'utilisateur de l'appareil doit accepter tout brouillage radioélectrique subi, même si le brouillage est susceptible d'en compromettre le fonctionnement.

Cet équipement est conforme à l'exposition aux rayonnements Industry Canada limites établies pour un environnement non contrôlé.

Contents

1	About Your New Label Printer
1	Registering Your Label Printer
1	Getting Started
2	Connecting the Power
3	Inserting and Removing the Label Cartridge
3	Removing the Label Backing
4	Using Your Label Printer
4	Power
5	LCD Display
5	Keypad
7	Creating a Label
8	Designing a Label
8	Changing the Text Size
8	Changing the Text Style
8	Creating Multi-Line Labels
9	Using International Characters
9	Using Barcodes
10	Adding Symbols
11	Using the Text Library
12	Creating a Series of Labels
14	Working with Label Files
14	Creating a Label File
14	Adding Labels to a Label File
14	Removing Labels from a File
15	Printing a Label File
15	Saving a Label File
15	Recalling a Label File from Memory
16	Deleting a Label File from Memory
16	User Templates
17	Using the Label Applications
17	Creating a Fixed Length Label
18	Creating a Vertical Label
18	Creating Cable Wrap Labels
19	Creating Flag Labels
19	Creating Laminated Cable Wrap Labels
20	Creating Heat-Shrink Labels
20	Creating a Distribution Panel Label
21	Creating a Patch Panel Label
22	Vertical Breaker Label
22	Horizontal Breaker Label
23	Creating Terminal Block Labels
24	Creating 110-Block Labels
25	Changing the Settings
25	Setting the Label Width
25	Auto Cut
26	Pausing to Cut between Labels

- 26 Collating Multiple Copies
- 26 Hiding the Caption Bar
- 27 Selecting a Language
- 27 Adjusting the Display Contrast
- 27 Adjusting the Print Contrast
- 27 Reset

28 Connecting the Label Printer to your Computer

- 28 Downloading and Installing DYMO ID™ Software
- 28 Connecting to your Computer
- 29 About DYMO ID Software
- 29 Transferring Files

30 Troubleshooting

31 Caring for Your Printer

- 31 Cleaning the Cutter Blade
- 31 Cleaning the Print Head

32 Safety Precautions for Rechargeable Battery

33 Symbols

34 Library Text

About Your New Label Printer

With the DYMO® RHINO™ 6000+ electronic label printer, you can design and print multiple label types, including barcode labels, panel labels, and heat shrink tubes. The label maker uses DYMO IND label cartridges in label widths of 1/4", 3/8", 1/2", 3/4", or 1" (6 mm, 9 mm, 12 mm, 19 mm, or 24 mm). Labels are available in a wide range of materials, such as flexible nylon, permanent polyester, vinyl, non-adhesive tag, and heat shrink tubes.

Visit www.dymo.com for information on obtaining labels and accessories for your label printer.

Registering Your Label Printer

Visit www.dymo.com/register to register your label printer online. During the registration process you will need the serial number, which is located inside the label compartment cover.

Register your label printer to receive these benefits:

- Notification of software upgrades by email
- Special offers and new product announcements

Getting Started

Become familiar with the parts of your label printer as shown in Figure 1.

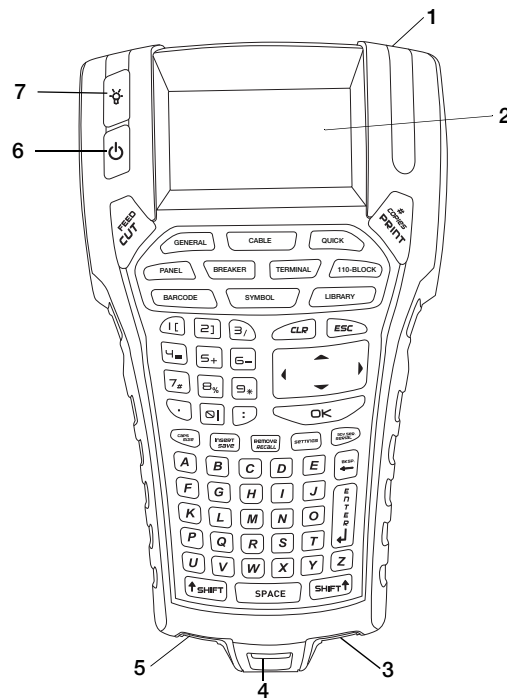

Figure 1

- | | | | | | |
|---|-----------------|---|--------------------------|---|------------|
| 1 | Label exit slot | 4 | Lanyard loop | 7 | Back light |
| 2 | LCD display | 5 | USB connector | | |
| 3 | Power connector | 6 | On/Off (Cancel printing) | | |

Connecting the Power

The label maker can operate on battery or AC power. A power adapter and a rechargeable battery are included with your printer.

To save power, the label maker will automatically turn off after five minutes of inactivity.

 Make sure to read the **Safety Precautions for Rechargeable Battery** on page 32.

Connecting the Power Adapter

The printer uses a 110V-240V power adapter. Connecting the power adapter with the battery inserted recharges the battery.

Use only the power adapter listed in this user guide:

Adapter model DSA-18PFM-09 Fc 090200 (note: “c” can be EU, UP, UK, US, UJ, JP, CH, IN, AU, KA, KR, AN, AR, BZ, SA, AF or CA) from Dee Van Enterprise Co., Ltd.

To connect the power adapter

- 1 Plug the power adapter into the power connector on the bottom of the label maker. See Figure 2.
- 2 Plug the other end of the power adapter into a power outlet.

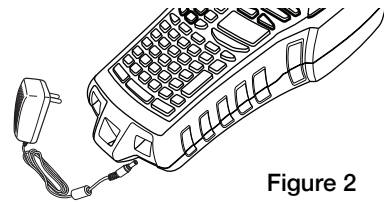



Figure 2

Inserting the Battery

The label printer is powered by a LiPolymer 7.4V 1400mAh 10.36Wh rechargeable battery. Only use the battery that came with the label printer.

 Make sure to read the **Safety Precautions for Rechargeable Battery** on page 32.

To insert the battery

- 1 Press the thumb latch on the back of the label maker to remove battery compartment cover. See Figure 3.
- 2 Insert the battery pack into the battery compartment.
- 3 Replace the battery compartment cover.

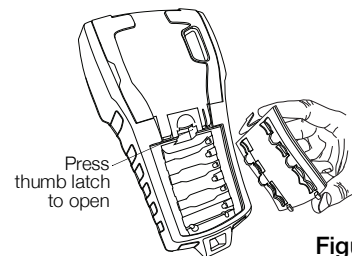

Figure 3

Recharging the Battery

The battery automatically recharges while the printer is connected to a power source through the power adapter. Charging the battery for the first time will take approximately 8 hours; recharging the battery will take approximately 3.5 to 4 hours.

Inserting and Removing the Label Cartridge

Your label maker comes with a starter IND label cartridge. Visit www.dymo.com information about purchasing additional label cartridges.

Each time you insert a label cartridge into the printer, you are prompted to set the label width so the printer knows what size label you are currently using. Some of the features you use to design labels are dependent on the width of the label.

However, to create a label for a width different than what is currently in the printer, you can set the label width from the Settings menu. See **Setting the Label Width** on page 25.

To insert the label cartridge

- 1 Gently lift the label cartridge door on the back of the printer.
- 2 Make sure the tape and ribbon are taut across the mouth of the cartridge and that the tape passes between the guides. If necessary, turn the ribbon rewind spool clockwise to tighten the ribbon.
- 3 Insert the cartridge with the tape and ribbon positioned between the guideposts.
- 4 Press gently on the cartridge until the cartridge moves into place. The insertion mechanism will guide the cartridge into place.
- 5 Close the label cartridge door.
- 6 Set the label width when prompted.

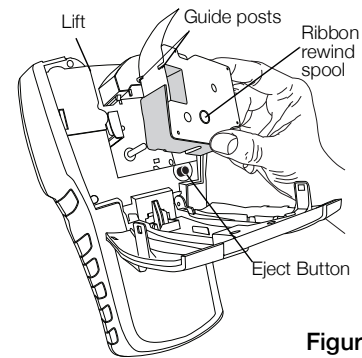



Figure 4

To remove the label cartridge

- 1 Gently lift the label cartridge door on the back of the printer.
- 2 Press the cartridge eject button. See Figure 4. The label cartridge is lifted from the printer.
- 3 Gently remove the label cartridge.
- 4 Insert a new label cartridge as described above.
- 5 Set the label width when prompted.

Removing the Label Backing

DYMO IND continuous labels have an easy-to-peel split back for easy removal of the label backing.

 Does not apply to heat-shrink tubing.

To remove the label backing

- 1 Locate the split on the label backing.
- 2 Gently pinch the label lengthwise, folding toward the printed side of the label. The label backing separates.
- 3 Carefully peel away the backing from the label.

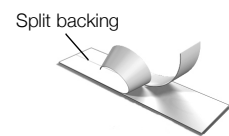

Using Your Label Printer

Become familiar with the feature and function keys on your label printer.

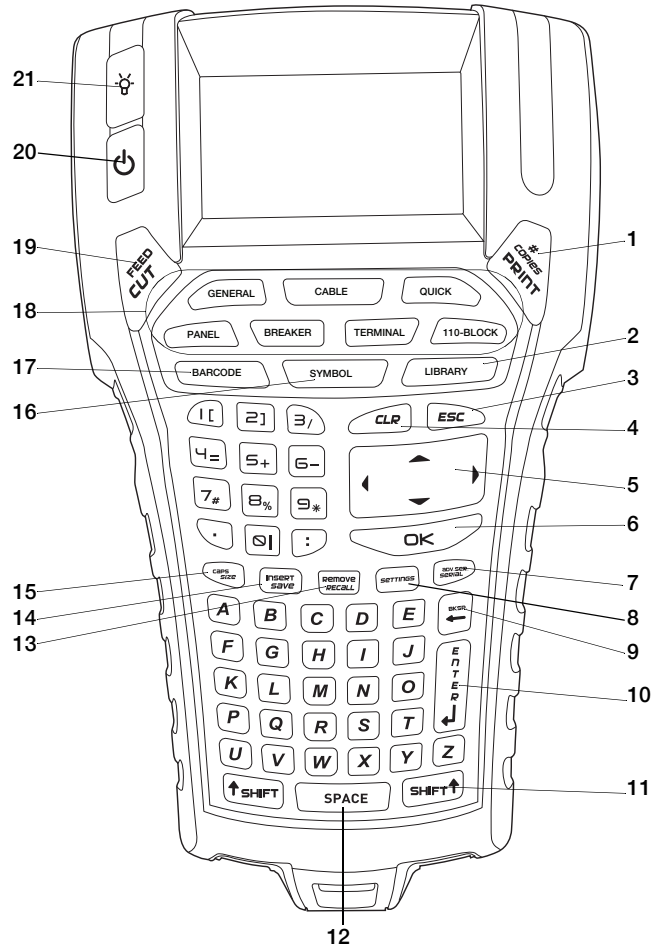



Figure 5

- | | | |
|----------------------------|-------------------------|------------------------------------|
| 1 Print/# of copies | 8 Settings | 15 Size/Caps |
| 2 Library | 9 Backspace | 16 Symbols |
| 3 Escape | 10 Enter | 17 Barcode |
| 4 Clear | 11 Shift | 18 Hot Keys |
| 5 Navigation | 12 Space bar | 19 Cut/Feed |
| 6 OK | 13 Recall/Remove | 20 On/Off (Cancel printing) |
| 7 Serialization | 14 Save/Insert | 21 Back light |

Power

The  button turns the power on and off. If no keys are pressed after five minutes, the power is turned off automatically.

When the printer is turned off, the current label file and its settings are remembered for the next time the printer is turned on. If the battery and power adapter are disconnected at the same time, some of the settings are

remembered; however, the current label file is lost and you will need to reset the label width when you reconnect the power and turn on the printer.

LCD Display

The label maker's LCD display includes a caption bar across the top, showing the current label type, and feature indicators on the right side, showing which features are currently selected. See Figure 6.

When the text you have entered will not fit on the label as currently defined, the portion of the text that will not fit is shaded. If you attempt to print the label containing text that will not fit, the excess text will not be printed.

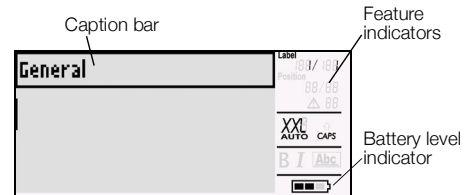

Figure 6

Using the Back Light

In low light conditions, you can turn on the back light to make it easier to see the display. To save power, the back light will turn off automatically after 15 seconds of inactivity. Pressing any key will turn the back light on again. The back light key acts as a toggle to turn the light on and off.

To toggle back light on and off

- ▶ Press .

Keypad

In addition to the alphanumeric keys, a number of function keys give you quick access to the features of your label printer.

Become familiar with the location of the feature and function keys on your label maker. See Figure 5 on page 4. The following sections describe each feature in detail.

CAPS Mode

The **CAPS** key toggles capitalization on and off. When CAPS mode is turned on, the **CAPS** indicator is shown on the display and all letters that you enter will be capitalized. The factory default setting is CAPS mode on. When CAPS mode is off, all letters entered appear in lower case.

To toggle CAPS on and off

- ▶ Press **CAPS** (SHIFT+ SIZE).

SHIFT Keys

The **SHIFT** keys are used to select the function or symbol printed above a key. For example, when you press the 9 key, the number 9 appears in the display; however, if you press **SHIFT** and then **9**, an asterisk (*) appears in the display. Pressing one of the Shift keys toggles the function on and off, so you do not need to hold down both keys together.

Escape Key

The **ESC** key returns you to the previous menu from within any menu without making a selection. Pressing the **ESC** key during printing will cancel the current print job.

Navigation Keys

The navigation keys operate as follows:

Key	Function
◀	Moves one character to the left in the display Returns to the previous menu (can also press ESC)
SHIFT ◀	Moves one label to the left in the display
▶	Moves one character to the right in the display Moves to the next menu level (can also press OK)
SHIFT ▶	Moves one label to the right in the display
▲	Moves up in a list of items
▼	Moves down in a list of items
OK	Selects a menu item

Backspace Key

The ← key removes the character to the left of the cursor.

Clear Key

The **CLR** key clears all current text settings and format, returning the display to the General label type.

CUT Key

The **CUT** key manually cuts the label. By default, the printer automatically cuts the label after printing. You can turn this Auto cut feature off and use the **CUT** key to manually cut the label. For more information, refer to **Auto Cut** on page 25 and **Pausing to Cut between Labels** on page 26

PRINT Key

Pressing the **PRINT** key prints one copy of the current label file. If the label file contains more than one label, you can choose which labels to print. Pressing **SHIFT + PRINT** lets you change the number of copies to print.

Hot Keys

A number of hot keys are quick ways to access the applications for creating specific types of labels and for adding barcodes, inserting symbols, and using the text from the library. These hot keys are described in detail later in this user guide.

Creating a Label

The label printer includes two types of basic labels: Quick and General. The current label type is shown in the display caption.

A Quick label is the default label type. The length of the label is determined by the text and formatting you use. Two layout properties can be set.

- Show an outline around the label contents.
- Match the leading and trailing space so the content is centered.

To create a Quick label

- 1 If not already the current label type, press **QUICK**.
- 2 Enter content
- 3 Press **SETTINGS** to format the text.

To change the properties, press **QUICK** again.

A General label is similar to a Quick label but this label type allows you to set two additional properties to define the label:

- Landscape or portrait (vertical) text orientation
- Label length

To create a General label

- 1 Press **GENERAL**.
- 2 Select the label length, orientation, and layout properties as appropriate.
- 3 Enter text.
- 4 Press **SETTINGS** to format the text.

To change the properties, press **GENERAL** again.

To save the label for later use, see **Saving a Label File** on page 15.

Designing a Label

You can choose from a number of options to enhance the appearance of your labels. You can also add a barcode, symbols, and library text to your label. And, you can create a series of labels automatically using three different serialization methods.

To create a fixed length label, use the General label application. See **Creating a Label** on page 7.

Changing the Text Size

You can print the text on your label in eight sizes: extra-extra-small (XXS), extra-small (XS), small (S), medium (M), large (L), extra-large (XL), extra-extra-large (XXL) and BIG (all capital letters). The text size selected applies to all the text on all the labels in a label file.

You can also select Auto as the text size. When Auto is selected, the best text size is automatically determined for the height and width of the label you are creating. BIG font is not available when Auto text size is selected.

The text sizes available for you to use depends on the width set for the label and the type of label you are creating.

To set the font size

- ▶ Press **SIZE**. Each time you press **SIZE**, the next available font size is highlighted on the Size feature indicator on the display.

You can also select the font size from the Settings menu.

Changing the Text Style

You can print the text on your label in several styles: bold, italic, underlined, and boxed. And, you can choose normal font width or narrow font width. The text style applies to all the text on all the labels in the label file, including most symbols.

To set the text style

- 1 Press **SETTINGS**.
- 2 Select **Text style** and press **OK**.
- 3 Use the arrow keys to select a style.
- 4 Press **OK** and then select **Done** (ESC).

Creating Multi-Line Labels

You can create multi-line labels depending upon the width of the label, as follows:

Label Width	1/4"	3/8"	1/2"	3/4"	1"
	(6 mm)	(9 mm)	(12 mm)	(19 mm)	(24 mm)
# Lines	1	3	3	5	5

The display shows two lines of text when the caption bar is displayed; or three lines with the caption bar hidden. Use the arrow keys to scroll through multiple lines. See **Hiding the Caption Bar** on page 26.

To create a multi-line label

- 1 Enter the text for the first line, and press **ENTER**.
- 2 Enter the text for the next line.
- 3 Repeat these steps for each additional line.

Using International Characters

The label maker supports the extended Latin character set using RACE technology. Similar to using a mobile phone keypad, holding down a letter key will scroll through variations of that letter.

For example, if you hold down the letter **a**, you will see **a à á â ã ä å** and so on through all the variations available. The order in which the character variations appear depends on the language you selected to use.

Using Barcodes

The label maker can generate several types of barcodes.

1D barcodes

Code 39	Code 39 mod 43	EAN 8	UPC A
Code 128	Codabar	EAN13	

2D barcodes

PDF 417	QR
---------	----

You can print a barcode only on 3/4" (19 mm) and 1" (24 mm) wide labels. You can choose to print the human-readable barcode text or not, and you can serialize barcodes.

The barcode prints horizontally along the label with the text in small print underneath the barcode. You can optionally add text before and after the barcode.



This User Guide assumes that you already understand the differences between barcode types and have a plan in place to incorporate barcodes into your organization. If you need to learn more about barcodes, many excellent how-to books are available at local libraries and book stores.

Adding a Barcode

The barcode text appears on the label in the display just like any other text. However, if the cursor is positioned within the barcode text, **Barcode** and the type of barcode are displayed in the caption bar.

To add a barcode

- 1 Press **BARCODE**.
- 2 Use the arrow keys to select the barcode type, and press **OK**.
- 3 Enter the text for the barcode and press **OK**.

Adding a QR Code

QR codes are limited to a maximum of 20 characters. For example, text or a phone number.

To add a QR code

- 1 Press **BARCODE**.
- 2 Use the arrow keys to select the **QR Code**, and press **OK**.
- 3 Enter the text for the QR code and press **OK**.

Editing a Barcode

You edit an existing barcode.

To edit a barcode

- 1 Move the cursor anywhere within the barcode text.
- 2 Press **BARCODE** or type a character.
A message appears asking if you would like to edit the barcode.
- 3 Press **OK**. The text of the existing barcode appears.
- 4 Edit the barcode text and press **OK**.

Deleting a Barcode

A barcode is entered on the label as one character.

To delete a barcode

- 1 Place the cursor at the end of the barcode on the display.
- 2 Press **←**.

Hiding Barcode Text

By default, show barcode text is turned on. You can choose to hide the barcode text.

To hide barcode text

- 1 Press **SETTINGS**.
- 2 Select **Barcode Text** and press **OK**.
- 3 Select **Off**.
- 4 Press **OK** and then select **Done** (ESC).

Adding Symbols

Your printer includes a set of default symbols to use on your labels. The symbols are separated into several categories:

Electrical	Brackets
Voice/Data	Arrows
Audio/Video	Numbers
Warning	Home Electrical
Punctuation	Currency

A complete list of the symbols can be found beginning on page 33.

Some of the more popular symbols can be accessed from the number keys using **SHIFT** plus the number. For example, pressing **SHIFT + 1** inserts an open bracket (**[**).

Symbols added to a label can be formatted or deleted just like any other character you enter.

To insert a symbol

- 1 Press **SYMBOL**.
- 2 Select a category of symbols.
- 3 Use the arrow keys to find the symbol you want.
- 4 Press **OK** to insert the symbol on the label.

Using the Text Library

Your printer includes a pre-defined text library. The library is separated into several categories:

Location	Voice/Data
Audio	Security
Video	

An additional category, called My Library, is available for you to add custom text to use on your labels.



My Library text is not displayed when you select All from the Library menu.

A complete list of pre-defined text strings can be found beginning on page 34.

Inserting Library Text

Library text added to a label can be edited, formatted, or deleted just like text you enter from the keypad.

To add text to a label

- 1 Press **LIBRARY**.
- 2 Select one of the categories or **My Library**.
- 3 Press the first letter of the text you wish to use.
The cursor jumps to the first text item that begins with that letter.
- 4 Press **OK** to insert the text on the label.

Adding My Library Text

You can add custom text to the library. Once text is added, you can use that text on a label in the same manner as pre-defined text items.

To add custom text

- 1 Press **LIBRARY**.
- 2 Use the arrow keys to select **My Library**.
- 3 Select **Add new text** and press **OK**.
- 4 Enter the text and press **OK**.
The text is added to My Library.

Deleting My Library Text

You can delete custom text from My Library.

To delete My Library text

- 1 Press **LIBRARY**.
- 2 Use the arrow keys to select **My Library**.
- 3 Select the text to delete.
- 4 Press **←**. A confirmation message appears.
- 5 Press **OK** to delete the text.

Creating a Series of Labels

You can automatically generate labels by creating a series. You create a starting pattern, and then set the increment and count for the series.

You can serialize any number or letter by selecting the position to be incremented, such as the number 2 in 123 or the letter B in ABC. For example, when the 2 is selected in 123 and the increment $\#=3$, the resulting labels would print as 123, 153, and 183.

Letters can be incremented from A to Z and a to z, and numbers from 1 to 9. When the letter Z or the number 9 is reached during serialization, a letter or number is added to increase the increment. For example, Az increments to Aaa, AZ increments to BA, and A9 increments to A10.

Three methods of serialization are available: simple, simultaneous, and advanced.

Using Simple Serialization

Simple serialization creates a series of labels by incrementing one alphanumeric character in the pattern. For example, 101, 102, 103, 104, and so on.

To use simple serialization

- 1 Enter the text for your label.
- 2 Press **SERIAL**. A box appears around the first character in the label.
- 3 Use the arrow keys to move the cursor to the position you wish to increment and press **OK**.
- 4 Select the amount you want to increment each label and press **OK**. You choose to increment in steps up to 10.
- 5 Select the number of labels you want to create and press **OK**.

The number of labels you can create is limited by the memory available.

A new label is added in the display for each label in the series.



To print multiple copies of the same serialized label, press **# COPIES** (SHIFT + PRINT) and enter the number of copies of each label to print.

Using Simultaneous Serialization

Simultaneous serialization creates a series of labels by incrementing two different alphanumeric characters at the same time. For example, A-101, B-102, C-103, and so on.

To use simultaneous serialization

- 1 Enter the text for your label.
- 2 Press **ADV.SER.** (SHIFT + SERIAL).
- 3 Select **Simultaneous** and press **OK**. A box appears around the character where the cursor was positioned.
- 4 Select the first character position you want to increment and press **OK**.
- 5 Select the second character position you want to increment and press **OK**.
- 6 Select the amount you want to increment these characters on each label and press **OK**. You can choose to increment in steps up to 10.
- 7 Select the number of times to increment these characters and press **OK**.

A new label is added in the display for each label in the series.

Using Advanced Serialization

Advanced serialization creates a series of labels by allowing you to select two sequences in the pattern and increment them consecutively.

For example, A-101, A-102, A-103, B-101, B-102, B-103, C-101, C-102, C-103, and so on.

To use advanced serialization

- 1 Enter the text for your label.
- 2 Press **ADV.SER.** (SHIFT + SERIAL).
- 3 Select **Advanced** and press **OK**. A box appears around the character where the cursor was positioned.
- 4 Select the first character position you want to increment and press **OK**.
- 5 Select the amount you want to increment this character position and press **OK**. You can choose to increment in steps up to 10.
- 6 Select the number of times to increment this character position and press **OK**.
- 7 Repeat Steps 4 through 6 for the second character position you want to increment.

A new label is added in the display for each label in the series.

Working with Label Files

The printer creates and stores labels as label files. A label file can contain one or more labels. When you create a new label, you also create a new label file. You can then insert additional labels, remove labels, and store the group of labels as a label file in memory.

Creating a Label File

The printer remembers the last label that you were working on when the power was turned off. You need to clear that label text and formatting before you create a new label.

To create a new label file

- 1 If necessary, press **CLR** to clear the previous label and formatting from the display.
- 2 Type some text using the keypad.
- 3 Format the text using **Text Size** or **Text Style**. See **Designing a Label** on page 8.
- 4 Save the label to memory. See **Saving a Label File** on page 15.

Adding Labels to a Label File

You can add additional labels to an existing label file.

To add a label to a file

- 1 Press **INSERT** (SHIFT + SAVE).
- 2 Select **To the right** to add a label to the right of the current label or **To the left** to add a label to the left of the current label.
- 3 Press **OK**.
A new blank label is inserted in the display to the left or right of the current label.

You can move from label to label using the arrow keys.

Removing Labels from a File

You can remove one or more labels from a label file.

To remove a label

- 1 Press **REMOVE** (SHIFT + RECALL).
- 2 Select one of the following:
 - **All** to remove all of the labels in the file.
 - **Current** to remove the label at the current cursor position.
 - **Range** and then select the range of labels to remove.
- 3 Press **OK**. The selected labels are removed from the display.

Printing a Label File

When you print a label file, you choose whether to print all of the labels, the current label, or a range of labels in the file.

To print labels

- 1 Press **PRINT**. If your label file contains more than one label, a print menu is displayed.
- 2 Select one of the following:
 - **All** to print all of the labels in the file.
 - **Current** to print the label at the current cursor position.
 - **Range** and then select the range of labels to print.
- 3 Press **OK**. The labels selected are printed.

Pressing **SHIFT + PRINT** lets you change the number of copies to print.

Pressing the **ESC** key during printing will cancel the current print job.

Saving a Label File

The label maker has a powerful memory feature that can store label files for later recall. The number of label files that can be stored is dependent on the size of the label files and the number of images they contain. The more images a file contains, the less memory that is available for storing label files.

When you save a label file, all the label text and formatting are saved. A label file name can be up to 20 alphanumeric characters in length.

To save a label file

- 1 Create the labels in your label file.
- 2 Press **SAVE**.
- 3 Use the arrow keys to select **New** and press **OK**.
- 4 Enter a name for your label file and press **OK**.
- 5 Press **CLR** to start a new label.

Recalling a Label File from Memory

Once a label is saved to memory, you can recall the label to print or edit. Recalling a label replaces the current label.

To recall a label from memory

- 1 Press **RECALL** and then select **Saved labels**.
- 2 Use the arrow keys to move to the memory location that contains the label you want and press **OK**.

A message appears confirming that you want to clear the current label text and formatting.
- 3 Press **OK**.

Deleting a Label File from Memory

When you no longer need a stored label, you can delete it from memory.

To delete a label from memory

- 1 Press **RECALL**. The saved label files are displayed.
- 2 Use the arrow keys to move to the label file you wish to delete.
- 3 Press **←** and then press **OK** to clear the memory location.

User Templates

When you transfer a simple label from DYMO ID software to the printer, the label file is saved as a user template. You can then open and modify the label file before printing and save it with a new name. See **Saving a Label File** on page 15.

To open a user template

- 1 Press **RECALL** and then select **User templates**.
- 2 Use the arrow keys to move to the label you want and press **OK**.
A message appears confirming that you want to clear the current label text and formatting.
- 3 Press **OK**.

Using the Label Applications

You can quickly create labels for special industrial applications.





Hot keys are available for each of the label types available. The current label type is displayed in the Caption bar. By default, the label type is Quick with no special formatting, text centered, and the length automatically determined by the amount of text.

The properties available on the printer are similar to the properties for the same label application in DYMO ID™ software. When you set the properties for a particular label type, those properties are remembered for the next time you choose that label type.

Creating a Fixed Length Label

Use a General label type to make a label for a specific purpose that is a fixed length regardless of the length of the text. Any text that does not fit within the fixed length appears shaded in the display and will be truncated when the label is printed.

The label properties you can set are:

Orientation	Landscape (Default) 
	Portrait 
Label length	Minimum: 1 1/4" (31.75 mm)
	Maximum: 20" (508 mm)
	Default: 2" (50.8 mm)
Label layout	Show label outline - Show label outline. Default is No. 
	Match/leader trailer - Blank space is equal at the beginning and end of the label. Default is Yes. 

To create a fixed length label

- 1 Press **GENERAL**.
- 2 Select the properties desired.
- 3 Select **Done** (ESC) to create the label.
- 4 Enter the text and formatting for the label and press **PRINT**.

Creating a Vertical Label

You can choose to print a label with the text running vertically. A label with multiple lines of text will print as multiple columns of text.

To print a vertical label

- 1 Press **GENERAL**.
- 2 Select the **Portrait** as the orientation property.
- 3 Select **Done** (ESC) to create the label.
- 4 Enter the text and formatting for the label and press **PRINT**.

Creating Cable Wrap Labels

A Cable Wrap label is placed around the width of a wire or cable. You can enter up to five lines of text and the text is repeated as many times as possible depending on the size of the text and the length of the label.

The label properties you can set are:

Cable type 	CAT 5/6, COAX, AWG: 4/0 - 2/0, AWG: 0 - 2, AWG: 3 - 5, AWG: 6+, or Custom
Cable diameter	Use when Custom is selected for Cable type. Minimum: 5/32" (4 mm) Maximum: 2" (50.8 mm)
Text repeat	AUTO or up to 15 times.

To create a vertical wrap label



- 1 Press **CABLE**.
- 2 Select **Cable Wrap** and press **OK**.
- 3 Select the properties desired.
- 4 Select **Done** (ESC) to create the label.
- 5 Enter the text for the label and press **PRINT**.

To create multiple labels quickly, see **Creating a Series of Labels** on page 12.

Creating Flag Labels

Flag labels wrap around a wire or cable leaving the text part of the label extending out from the cable. The text on flag labels is automatically printed on both ends of the label leaving a blank space in the middle that wraps around the cable. When the label is applied to the cable, both ends of the label are applied back to back leaving a tail or *flag*. The result is a label that can be read from both sides.

The label properties you can set are:

 Cable type	CAT 5/6, COAX, AWG: 4/0 - 2/0, AWG: 0 - 2, AWG: 3 - 5, AWG: 6+, or Custom
Diameter	Use when Custom is selected for Cable type. Minimum: 5/32" (4 mm) Maximum: 2" (50.8 mm)
 Flag length	Minimum: 7/16" (11.1 mm) Maximum: 10" (254 mm)
 Layout	Show label outline - Show label outline. Default is No.

To print a flag label

- 1 Press **CABLE**.
- 2 Select **Flag** and press **OK**.
- 3 Select the properties desired.
- 4 Select **Done** (ESC) to create the label.
- 5 Enter the text for the label and press **PRINT**.

To create multiple labels quickly, see **Creating a Series of Labels** on page 12.

Creating Laminated Cable Wrap Labels

The Laminated Cable Wrap label is designed to be used with Rhino Self-Laminating Labels (part number 1734821). The text of the label is printed on the top portion of the label so the clear, bottom half of the label can wrap around and cover the text.

The Self-Laminating label is 24 mm wide; however, you can only enter two lines of text and are limited to using extra-extra-small, extra-small, and small font sizes.

The label property you can set is:

 Label length	Minimum: 1.25" (31.7 mm) Default: 20" (50.8 cm)
---------------------------------------------------------------------------------------------------------	----------------------------------------------------





To print a self-laminating label

- 1 Press **CABLE**.
- 2 Select **Laminated Cable Wrap** and press **OK**.
- 3 Select the **Label length** and press **OK**.
- 4 Select **Done** (ESC) to create the label.
- 5 Enter the text for the label and press **PRINT**.

To create multiple labels quickly, see **Creating a Series of Labels** on page 12.

Creating Heat-Shrink Labels

The heat-shrink tube label is one of several cable management specific labels. Heat shrink tube labels can be printed on any continuous Heat-Shrink Tube labels. The label properties you can set are:

Orientation	Landscape (Default) 
	Portrait 
Label length	Minimum: 1 1/4" (31.75 mm) Maximum: 2" (508 mm) Default: 2" (50.8 mm)
Label layout	Show label outline - Show label outline. Default is No.  Match/leader trailer - Blank space is equal at the beginning and end of the label. Default is Yes. 

To create a heat-shrink label

- 1 Press **CABLE**.
- 2 Select **Heat-Shrink** and press **OK**.
- 3 Select the properties desired.
- 4 Select **Done** (ESC) to create the label.
- 5 Enter the text for the label and press **PRINT**.

To create multiple labels quickly, see **Creating a Series of Labels** on page 12.



Creating a Distribution Panel Label

Distribution panel labels are created by specifying the number of connectors and the center-to-center distance between each connector.



Use serialization to automatically populate the connectors. When all the connectors are filled on the current label, a new label is created. See **Creating a Series of Labels** on page 12.

The label properties you can set are:

# of connectors	Maximum of 48 connectors.
Center to center distance	Distance from the center of one port to the center of the next port.  Minimum: 5/32" (3.8 mm) Maximum: 20" (508 mm)
Label layout	Show label outline - Show label outline. Default is No.  Show separator lines - Print a separator line between each port. (Default is Yes.) 

To create a distribution panel label

- 1 Press **PANEL**.
- 2 Select **Distribution Panel** and press **OK**.
- 3 Select the properties desired.
- 4 Select **Done** (ESC) to create the label.
Each connector is separated by a solid black line on the display.
- 5 Enter the text for each connector in the label. Use the left or right arrow key to move from connector to connector.

Creating a Patch Panel Label

A Patch panel label allows you to label a row of ports on a patch panel. You select the properties for the label, enter the desired text, and print. The result is a long label with multiple, evenly spaced text for each port.



Use serialization to automatically populate the ports. When all the ports are filled on the current label, a new label is created. See **Creating a Series of Labels** on page 12.

The label properties you can set are:

# of ports	Maximum of 48 ports	
Center to center distance	Distance from the center of one port to the center of the next port. Minimum: 5/32" (3.8 mm) Maximum: 20" (508 mm)	
In groups of	Number of groups. Default is 6.	
Group clearance	Distance between groups of ports when one continuous label is selected. Minimum: 1/64" (0.4 mm) Maximum: 20" (508 mm)	
Label setup	<p>One label for all ports - Print groups of ports as one continuous label. </p> <p>One label per group - Print each group of ports as a separate label. (Default) </p>	
Label layout	<p>Show label outline - Show label outline. Default is No. </p> <p>Show separator lines - Print a separator line between each port. (Default is Yes.) </p>	

To create a patch panel label

- 1 Press **PANEL**.
- 2 Select **Patch Panel** and press **OK**.
- 3 Select the properties desired.
- 4 Select **Done** (ESC) to create the label.
Each port is separated by a solid black line on the display.
- 5 Enter the text for each port in the label. Use the left or right arrow key to move from port to port.



Vertical Breaker Label

The vertical breaker label is one of two types of labels for use on a breaker box. See **Horizontal Breaker Label** on page 22.



Use serialization to automatically populate the breakers. When all the breakers are filled on the current label, a new label is created. See **Creating a Series of Labels** on page 12.

The label properties you can set are:

# of breakers	Maximum: 48 breakers
Single breaker height	Minimum: 1/4" (6.35 mm); Maximum: 20" (500 mm)
# of poles	Number of poles for each breaker. Maximum: 3
Print empty breakers	Yes or No. Default is Yes.
Label layout	Show label outline - Show label outline. Default is No. 
	Show separator lines - Print a separator line between each port. (Default is Yes.) 
	Match/leader trailer - Blank space is equal at the beginning and end of the label. Default is Yes. 

To create a vertical breaker label

- 1 Press **BREAKER**.
- 2 Select **Vertical Breaker** and press **OK**.
- 3 Select the properties desired.
- 4 Select **Done** (ESC) to create the label.
Each breaker is separated by a solid black line on the display.
- 5 Enter the text for each breaker in the label. Use the left or right arrow key to move from breaker to breaker.



Horizontal Breaker Label

The horizontal breaker label is one of two types of labels for use on a breaker box. See **Vertical Breaker Label** on page 22.



Use serialization to automatically populate the breakers. When all the breakers are filled on the current label, a new label is created. See **Creating a Series of Labels** on page 12.

The label properties you can set are:

# of breakers	Maximum: 48 breakers	
Single breaker width	Minimum: 1/4" (6.35 mm); Maximum: 20" (500 mm)	
Multiplier	Multiplier for each breaker. Minimum: 0.5 Maximum: 4 Can be manually entered in 0.5 increments, such as 2.5, 3.5 and so on.	
Print empty breakers	Yes or No. Default is Yes.	
Label layout	<p>Show label outline - Show label outline. Default is No. </p> <p>Show separator lines - Print a separator line between each port. (Default is Yes.) </p> <p>Match/leader trailer - Blank space is equal at the beginning and end of the label. Default is Yes. </p>	

To create a horizontal breaker label

- 1 Press **BREAKER**.
- 2 Select **Horizontal Breaker** and press **OK**.
- 3 Select the properties desired.
- 4 Select **Done** (ESC) to create the label.
Each breaker is separated by a solid black line on the display.
- 5 Enter the text for each breaker in the label. Use the left or right arrow key to move from breaker to breaker.





Creating Terminal Block Labels

Terminal block labels are created by specifying the orientation (portrait or landscape), the number of blocks, and the block height.



Use serialization to automatically populate the blocks. When all the blocks are filled on the current label, a new label is created. See **Creating a Series of Labels** on page 12.

The label properties you can set are:

Orientation	<p>Landscape (Default) </p> <p>Portrait </p>	
# of blocks	Maximum: 48 blocks	
Block height	Minimum: 5/32" (3.8 mm) Maximum: 20" (508 mm)	
Label layout	<p>Show label outline - Show label outline. Default is No. </p> <p>Show separator lines - Print a separator line between each port. (Default is Yes.) </p> <p>Match/leader trailer - Blank space is equal at the beginning and end of the label. Default is No. </p>	

To create a terminal block label

- 1 Press **TERMNAL**.
- 2 Select the properties desired.
- 3 Select **Done** (ESC) to create the label.
Each breaker is separated by a solid black line on the display.
- 4 Enter the text for each breaker in the label. Use the left or right arrow key to move from breaker to breaker.



Creating 110-Block Labels

The 110-block label is one of several datacom specific labels. You enter data into one of three pre-defined block formats depending on the block type you select.



Use serialization to automatically populate the blocks. When all the blocks are filled on the current label, a new label is created. See **Creating a Series of Labels** on page 12.

The label properties you can set are:

Block type	C4-4 pair - Data grade C4-4 pair - Voice grade C5-5 pair - Voice grade
Label layout	Show label outline - Show label outline. Default is No.  Match/leader trailer - Blank space is equal at the beginning and end of the label. Default is Yes. 

To create a 110-block label

- 1 Press **110-BLOCK**.
- 2 Select the properties desired.
- 3 Select **Done** (ESC) to create the label.
Each block is separated by a solid black line on the display.
- 4 Enter the text for each block in the label. Use the left or right arrow key to move from block to block.

Changing the Settings

Text size, text style, Caps mode, and hide/show barcode text settings are described elsewhere in this user guide.

You can change the following settings:

- **Setting the Label Width**
- **Auto Cut**
- **Pausing to Cut between Labels**
- **Collating Multiple Copies**
- **Hiding the Caption Bar**
- **Selecting a Language**
-
- **Adjusting the Display Contrast**
- **Adjusting the Print Contrast**
- **Reset**

All settings remain in effect until you change them again.

Setting the Label Width

Each time you insert a label cartridge into the printer, you are prompted to set the label width so the printer knows what size label you are currently using. Some of the features you use to design labels are dependent on the width of the label.

However, to create a label for a width different than what is currently in the printer, you can set the label width from the Settings menu.

To set the label width

- 1 Press **SETTINGS**. The Settings menu appears on the display.
- 2 Select **Tape width**.
- 3 Select the width of the labels currently inserted in the printer.
- 4 Press **OK** and then select **Done (ESC)**.

Auto Cut

By default, labels are automatically cut after printing. You can choose to turn off auto cut and manually cut each label.

To change the auto cut setting

- 1 Press **SETTINGS**.
- 2 Select **Auto cut** and press **OK**.
- 3 Use the arrow keys to select **On** or **Off**.
- 4 Press **OK**, and then select **Done (ESC)**.

Pausing to Cut between Labels

When Auto Cut is turned off, multiple labels will print continuously until all labels are printed. You can choose to pause printing between each label so you can manually cut each label as they print.

To set the printer to pause between each label

- 1 Press **SETTINGS**.
- 2 Make sure **Auto cut** is turned off.
- 3 Select **Pause to cut btw labels** and press **OK**.
- 4 Select **On**.
- 5 Press **OK** and then select **Done (ESC)**.

Collating Multiple Copies

When printing multiple copies of a label file containing more than one label, all the copies of a label are printed before the next label starts printing. You can choose to have the label file print collated, so each complete copy of the file prints before the second copy starts. The following example shows three copies of a label file containing three labels printed normally and collated.

Normal

A101 A101 A101 A102 A102 A102 A103 A103 A103

Collated

A101 A102 A103 A101 A102 A103 A101 A102 A103

To collate multiple copies

- 1 Press **SETTINGS**.
- 2 Select **Collate copies** and press **OK**.
- 3 Select **On**.
- 4 Press **OK** and then select **Done (ESC)**.

Hiding the Caption Bar

The caption bar at the top of the display shows the current label type and for some label types, additional information about the label, such as size or barcode type. The caption bar can be hidden to allow more lines of the label to be shown in the display. This is very useful for multi-line labels.

To hide the Caption bar

- 1 Press **SETTINGS**.
- 2 Select **Caption Bar** and press **OK**.
- 3 Select **Hide**, press **OK**, and then select **Done (ESC)**.

Selecting a Language

Several language-related features on the label maker are determined by the language setting, such as special characters, menu text, and so on. By default the language is set to English.

To select a language

- 1 Press **SETTINGS** and select **Language**.
- 2 Select the language.
- 3 Press **OK** and then select **Done (ESC)**.

The language displayed is immediately changed.

Adjusting the Display Contrast

In addition to back-lighting, you can adjust the display contrast to help in different lighting conditions.

To adjust the display contrast

- 1 Press **SETTINGS**.
- 2 Select **LCD contrast** and press **OK**.
- 3 Use the arrow keys to select a value between **0** (lighter) and **8** (darker). The contrast changes as you select the different settings.
- 4 Press **OK**, and then select **Done (ESC)**.

Adjusting the Print Contrast

Depending on the label material you choose, you may need to lighten or darken the print on the label.

To adjust the print contrast

- 1 Press **SETTINGS**.
- 2 Select **Print contrast** and press **OK**.
- 3 Use the arrow keys to adjust the contrast percentage.
- 4 Press **OK**, and then select **Done (ESC)**.
- 5 Repeat as necessary until you are satisfied with the print quality.

Reset

You can reset the printer to its default settings. All your previous settings and saved label files will be removed.

To reset the printer

- 1 Press **SETTINGS**.
- 2 Select **Default reset** and press **OK**.
- 3 Use the arrow keys to select **Yes**.
- 4 Press **OK** when prompted to remove user data.

Connecting the Label Printer to your Computer

The label printer can be used as a standalone label printer or you can print labels directly from your computer using the latest version of DYMO ID™ software.

Using DYMO ID™ software is the recommended method for producing a high-volume of labels.

Downloading and Installing DYMO ID™ Software

 Do not connect the label printer to your computer until after the software installation is complete.

To install the software

- 1 Download the latest version of DYMO ID™ software from the DYMO Web site at support.dymo.com.
- 2 Follow the instructions in the installer.

Connecting to your Computer

The label printer connects to your computer using the USB connection located on the bottom of the label printer.

 Do not connect the label printer to your computer until after the software installation is complete.

To connect the label printer to your computer

- ▶ Plug the USB cable into the USB connector on the label printer and into an available USB port on your computer.

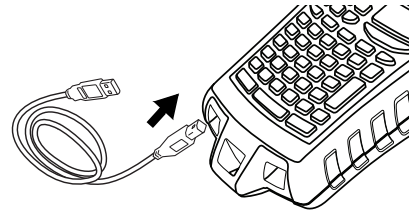



Figure 7
You can now print directly from DYMO ID™ software.

Refer to the DYMO ID software Online Help for complete information about using the label printer while connected to your computer.

 While the printer is connected to your computer, **PC Connected... Do not disconnect** is displayed on the printer and you cannot use any of the printer functions.

About DYMO ID Software

The following figure shows some of the major features available with DYMO ID™ software.

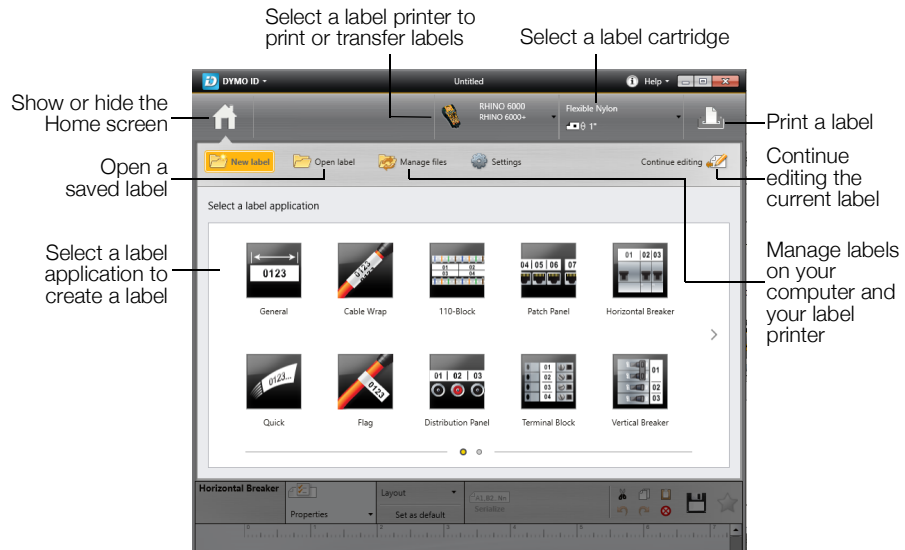

For complete details on using the software, refer to the online Help or the DYMO ID™ *User Guide*.

From the Help menu in DYMO ID™ software, you can view the following:

- DYMO ID™ Help
- *DYMO ID™ User Guide*

Transferring Files

You can only transfer files to your label printer using DYMO ID™ software that were created with the Rhino Quick label application. Transferred labels are saved as user templates. See **User Templates** on page 16.

Refer to the DYMO ID™ software online Help or user guide for complete information on transferring files.

Troubleshooting

Review the following possible solutions if you encounter a problem.

Problem/Error Message	Solution
Battery Low Battery Empty 	<ul style="list-style-type: none"> ■ Attach the power adapter. ■ Recharge the battery. See Recharging the Battery on page 2.
Poor Print Quality	<ul style="list-style-type: none"> ■ Clean the print head. See Cleaning the Print Head on page 31. ■ Adjust the print contrast. See Adjusting the Print Contrast on page 27.
Tape Jam Motor is stalled due to tape jam.	<ul style="list-style-type: none"> ■ Open the label cartridge compartment and press the eject button to release the cartridge. ■ Remove the label, clearing the jam. ■ Make sure the label passes smoothly through the guideposts on the label cartridge. See Inserting and Removing the Label Cartridge on page 3. ■ When the jam is cleared, press OK to clear the display.
Clean Cutter: Remind later?	<ul style="list-style-type: none"> ■ Clean the cutter blade. See Cleaning the Cutter Blade on page 31.
Uneven or slanted printing The cartridge is not inserted correctly.	<ul style="list-style-type: none"> ■ Check the label cartridge compartment to make sure the cartridge is inserted properly. See Inserting and Removing the Label Cartridge on page 3. ■ Make sure the cartridge is seated completely. Let the printer mechanism do the work.
Cannot close the tape cartridge lid The cartridge is not inserted correctly.	Make sure nothing is blocking the cartridge cover and that the label cartridge is inserted properly. See Inserting and Removing the Label Cartridge on page 3.
Unable to return to the previous menu	<ul style="list-style-type: none"> ■ Press ESC to return to the previous menu. ■ Press Clr to return to the display and clear all settings.
Nothing shows on the display	<ul style="list-style-type: none"> ■ Ensure the label maker is turned on. ■ Recharge battery or plug in power adapter. ■ Remove power adapter and battery and reattach power to restart the printer.
End of Tape label cartridge is empty.	The printer cannot detect the end of the label cartridge. Make sure you have labels left in the cartridge before starting a large print job.
Display text is too light to read	<ul style="list-style-type: none"> ■ Turn on back light. See Using the Back Light on page 5. ■ Adjust the display contrast. See Adjusting the Display Contrast on page 27.
Too many lines Too many lines for this tape width.	<ul style="list-style-type: none"> ■ Reduce the number of text lines. ■ Insert a wider label cartridge.
Barcode not allowed	<ul style="list-style-type: none"> ■ Replace the label cartridge. ■ Change the label width to a 3/4" (19 mm) or 1" (24 mm) wide cartridge.
Self-Lam is not allowed	Laminated cable wrap labels can only be printed on 1" (24 mm) Self-Laminated labels. <ul style="list-style-type: none"> ■ Replace the label cartridge. ■ Change the label width to 1" (24 mm).
Print error... The tape is jammed.	<ul style="list-style-type: none"> ■ Open the label cartridge lid and check that the tape is not jammed. ■ Pull a small amount of tape from the cartridge to make sure the tape moves freely.
No response when pressing keys One of the keys may be jammed.	<ul style="list-style-type: none"> ■ Press each key to determine which key is jammed. ■ Press the jammed key firmly until it returns to its normal position.

If you still need assistance, contact DYMO Customer Support for your country at support.dymo.com.

Caring for Your Printer

Your label printer is designed to give you long and trouble-free service, while requiring very little maintenance. Clean your printer regularly to keep it working properly.



Cleaning the Cutter Blade

Periodically, the message **Clean cutter** will display. This is a reminder to clean any adhesive build up on the cutter blade so that your labels will continue to cut with no problems.



Caution: The cutter blade is extremely sharp.

To clean the cutter blade

- 1 Turn off the power and remove the label cartridge.
- 2 Press and hold the **CUT** key while pressing down the  button for 2 seconds.
- 3 Release  button and **CUT** key.
The display shows the message **Move cutter blade**.
- 4 While holding down the **Shift** key, press and release the **CUT** key repeatedly. Each press of the **CUT** key will move blade position a little bit.
- 5 With the label cartridge cover open, move the blade little by little until it reaches the top position.
- 6 Press down the plastic cutter framework, use cotton swab and alcohol to clean glue on cutter.



Make sure the alcohol only touches the cutter blade. Excess alcohol that touches the rubber frame can damage the frame.

- 7 When the blade is clean, press the **CUT** key once to return the blade to the starting position.

Cleaning the Print Head

A print head cleaning tool is located on the inside of the label cartridge door.



The cutter blade is extremely sharp. Avoid direct contact with the **CUT** key or blade while cleaning the print head.

To clean the print head

- 1 Remove the label cartridge.
If you do not have a cleaning tool, contact DYMO Customer Care (support.dymo.com).
- 2 Using a print head cleaning tool, gently wipe the padded side of the tool across the print head.

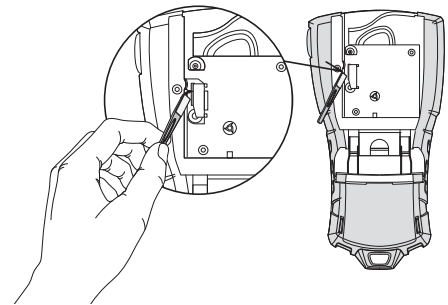

Safety Precautions for Rechargeable Battery

Battery type: LiPolymer 7.4V 1400mAh 10.36Wh

Inaccurate handling of a lithium-ion polymer rechargeable battery may cause leakage, heat, smoke, an explosion, or fire. This could cause deterioration of performance or failure. This may also damage the protection device installed in the battery. This could damage equipment or injure users. Thoroughly follow the instructions below.



Danger

- Use the battery only in the Rhino 6000+ label printer.
- Battery can only be charged while inserted in the label printer using the charging adapter provided (9VDC/2A).
- Do not connect directly to an electric outlet or cigarette lighter charger.
- Do not store battery close to fire or inside the car where temperature may be over 60°C.



Warning

- Stop charging the battery if charging is not completed within 3.5 hours.



Caution

- Do not use the label printer or battery in a place that generates static electricity.
- Use the label printer only at room temperature.
- Battery can only be charged within +10°C to 35°C temperature range.
- Battery can only be discharged within -10°C to 60°C temperature range.
- Use only an authentic DYMO battery.

Electrical Rating

Printer	Input: 9V, 2.0A
Power adapter	Input: 100-240V 50/60Hz 0.6A Output: 9V, 2.0A

Symbols

The following tables list the default symbols by category.

Electrical



Voice/Data



Audio/Video



Warning

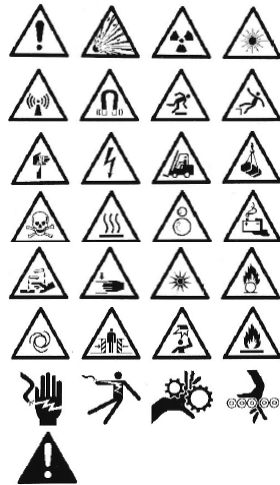

Punctuation

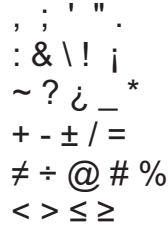

Brackets



Arrows

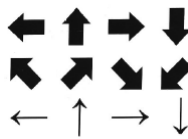

Numbers

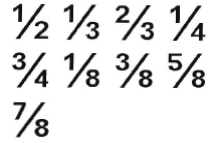

Currency



Home Electrical



Library Text

The following tables list the library text by category.

Location

ATTIC	KITCHEN
BACK	LAUNDRY ROOM
BASEMENT	LEFT
BATH	LIBRARY
BEDROOM	LIVING ROOM
BILLIARDS ROOM	LOBBY
CENTER	LOWER
CLOSET	MAIN FLOOR
DECK	MASTER BATH
DEMARC	MASTER BEDROOM
DEN	MEDIA ROOM
DINING ROOM	OFFICE
DRESSING ROOM	OUTSIDE
DRIVEWAY	PATIO
FAMILY ROOM	PLAY ROOM
FLOOR	POOL
FOYER	PORCH
FRONT	RIGHT
GARAGE	SITTING ROOM
GATE	SPA
GUEST BATH	STUDY
GUEST HOUSE	SUNROOM
GUEST ROOM	THEATER
GYM	UPPER
HOT TUB	UTILITY ROOM
INSIDE	YARD

Audio

ANALOG	PHONO
CD	RIGHT BACK SPKR
CENT FRONT SPKR	RIGHT FRONT SPKR
CENTER BACKSPKR	RIGHT OUTD. SPKR
DIGITAL	RIGHT SIDE SPKR
LEFT BACK SPKR	RIGHT SURR. SPKR
LEFT FRONT SPKR	SPEAKER
LEFT OUTD SPKR	SUBWOOFER
LEFT SIDE SPKR	SURROUND
LEFT SURR. SPKR	TAPE
OPTICAL	VOLUME CONTROL
	ZONE

Video

CATV	RF
COMPONENT	RGB
COMPOSITE	RS-232
DVD	REMOTE
DVI	S-VIDEO
DVR	SAT
HDMI	TV
HDTV	TOUCH SCREEN
IR	VCR
KEYPAD	VESA
MONITOR	VIDEO GAME
NANNY CAM	
PROJECTOR	

Voice/ Data

CO	LAN
CABLE MODEM	LAPTOP
DSL	NETWORK
DSLAM	PHONE
DEMARC	PHONE SYSTEM
DESKTOP	USB
FAX	VoIP
INTERNET	WIRELESS

Security

BACK DOOR	HEAT DETECTOR
CCTV	HIGH WATER
CAMERA	HORN
CARBON MONOXIDE	LOW TEMP
CELL	MOTION SENSOR
CONTACT	PIR
CONTROLLER	PHONE
DOOR	POOL
DOOR CONTACT	POWER
DRIVEWAY	REMOTE
DUAL TECH	SENSOR
DUCT	SHOCK SENSOR
FAN CUTOFF	SIREN
FRONT DOOR	SLIDERS
GARAGE DOOR	SMOKE DETECTOR
GAS	SPARE
GATE	STROBE
GLASS BREAK	WATER DETECTOR
GROUND	WINDOW
	WINDOW SENSOR
